









The following pages have been designed to help HC100 users get the most from their wristband printing solution and to assist in training new users. Below are 3 symptoms reported to us by users along with our recommended resolutions.

CARTRIDGE		
BOTTOM TURN CARTRIDGE UPSIDE DOWN	MEDIA WINDOW	PRINTER LIGHTS
		
<p>Symptom A: Wristband partially sticking out, printer stopped, orange error light flashes.</p>		<p>Resolution: <u>DO NOT PULL WRISTBAND OUT OF PRINTER OR CARTRIDGE.</u> Eject cartridge. Using scissors cut the protruding part of the wristband as close as possible to the edge of the cartridge. Re-insert cartridge in your HC100 printer, the remaining band should automatically feed out. Ensure printer has most up-to-date firmware. See next page for instructions on checking and upgrading firmware.</p>
		
<p>Symptom B: Wristband not visible from underside of cartridge but is visible through media window. Cartridge is not recognised by printer, orange error light flashes.</p>		<p>Resolution: Wristband has been pulled out of printer, before it had finished printing, or has been pulled out of cartridge following symptom A, above. User training is required to ensure;</p> <ul style="list-style-type: none"> a) wristbands are removed from printer only when printer has finished printing b) wristbands are not forcibly pulled out of printer c) wristbands are not forcibly pulled out of cartridge d) follow instructions above should symptom A occur
		
<p>Symptom C: Wristband is visible from underside of cartridge & media window. Cartridge is not recognised by printer, orange error light flashes.</p>		<p>Resolution: Eject cartridge and re-insert. If problem persists, ensure printer has most up-to-date firmware and re-insert. See next page for instructions on checking and upgrading firmware. If problem persists despite latest firmware version, complete form on page 6 and return to reseller.</p>

Routine Maintenance

For best results from your printer, Zebra recommends that users upgrade to the latest firmware version* and carry out routine maintenance as follows;

Determining Firmware Version

To determine your current firmware version, complete the following steps to print a configuration wristband:

- Make sure the printer is on and ready to print with a wristband cartridge inserted.
- Press and hold PAUSE/FEED until the green lights turn off on the printer status indicators, and the orange lights blink once.
- Release PAUSE/FEED. A wristband prints with the printer configurations details and firmware version.

The example below shows version V54. 17.14Z.

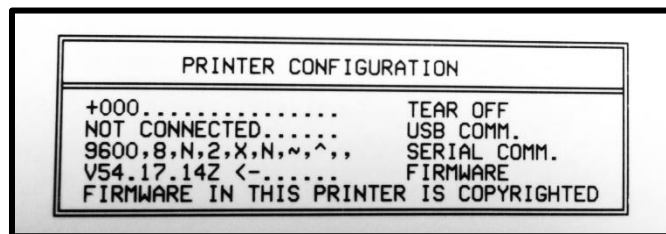

The latest version number of firmware can be seen and downloaded from the 'firmware and service packs' section of the HC100 pages of our web site at; http://www.zebra.com/gb/en/support-downloads/desktop/hc-100.html#mainpartabscontainer_5e2d=firmware-servicepacks

If your printer configuration* has an earlier version, Zebra recommend upgrading to the latest version for best results.

**Original WLAN (802.11b/g) enabled HC100 printers, i.e. part number HC100-300x-0200, will only support older versions of firmware. Firmware upgrades should not be attempted on these printer configurations.*

Updating Firmware

Full firmware download details can be viewed on page 73 of the printer's associated user manual. <http://www.zebra.com/content/dam/zebra/manuals/en-us/printer/hc100-ug-en.pdf>



CAUTION - During the firmware download process, the printer status indicator turns to a steady half-orange and half-green state as the printer writes to flash memory. Do NOT power cycle the printer during this phase. Doing so makes the printer inoperable.

For help with the following maintenance instructions, please refer to the diagrams on page 5

Cleaning the Media Path Using a Swab and Alcohol/Water Mix



CAUTION – Remove all rings, watches, hanging necklaces, identification badges, or other metallic objects that could touch the printhead or drop into the media cartridge slot.



CAUTION – Before proceeding, discharge any built-up static electricity by touching the printer's metal back plate near its power switch or by using an anti-static wriststrap and mat.



CAUTION – The printhead may be hot and could cause severe burns. Allow the printhead to cool.

Use the swab from a Preventative Maintenance Kit (part 47362) or a clean swab dipped in a solution of isopropyl alcohol (90%) and deionized water (10%).

1. Press the Eject button and remove the media cartridge from the printer.
2. Turn off the printer power
3. Refer to Figure 4. Press both upper cover release buttons simultaneously; the upper cover will partially open.
4. Refer to Figure 6. Rotate the upper cover up and back.
5. Refer to Figure 7. Grasp the metal lever plate on the printhead assembly and rotate upward to expose the printhead elements.
6. Refer to Figure 8. Using the swab from the Preventative Maintenance Kit or a swab dipped in the alcohol solution, wipe along the brown strip on the printhead assembly from end to end. Allow the solution to evaporate.
7. Refer to Figure 9. Using the swab, wipe the media chute surfaces. Allow the solution to evaporate.
8. Refer to Figure 10. Rotate the two side clips on the platen roller upward.
9. Refer to Figure 11. Remove the platen roller from the printer.
10. Refer to Figure 12. Using the swab, thoroughly clean the platen roller. Allow the solution to evaporate.
11. Refer to Figure 13. Place the platen roller back into its place in the printer.
12. Refer to Figure 14. Secure the platen roller by rotating the two side clips back into place.
13. Refer to Figure 15. Align the snap tabs on the bottom of the media chute with the slots in the printer chassis.
14. Refer to Figure 16. Press down on the metal lever plate to snap the printhead assembly back into place.
15. Refer to Figure 17. Close the upper cover.
16. Turn on the printer power and reinsert the wristband cartridge. Dispose of the used swab according to your local regulations.

Cleaning the Smart Card and Contacts



CAUTION – Remove all rings, watches, hanging necklaces, identification badges, or other metallic objects that could touch the printhead or drop into the media cartridge slot.



CAUTION – Before proceeding, discharge any built-up static electricity by touching the printer's metal back plate near its power switch or by using an anti-static wriststrap and mat.

1. Press the Eject button and remove the wristband cartridge from the printer
2. Turn the printer off
3. Disconnect the power cord from the back of the printer
4. Refer to Figure 1. Using the cleaning swab from the Preventative Maintenance Kit, or a swab dipped in isopropyl alcohol/deionized water solution (mixed 90/10), clean the gold smart card contacts on the back of the wristband cartridge. Allow the solution to evaporate before putting the cartridge back in the printer.
5. Refer to Figure 2. Using the cleaning swab and vertical strokes, clean the gold media cartridge sensor pins, which are visible at the back of the media cartridge slot. Allow the solution to evaporate before proceeding.
6. Insert the power cord into the back of the printer
7. Turn on the printer power and reinsert the wristband cartridge. Dispose of the used swab according to your local regulations.
8. If your wristband cartridge is still not recognized, fill out the form on page 6 and submit the form to your reseller.

Cleaning the Printhead Using Cleaning Card

1. Press the Eject button and remove the wristband cartridge from the printer.
2. Turn the printer off.
3. Remove the cleaning card (part 61332M) from its packaging.
4. Refer to Figure 4. Press both upper cover release buttons simultaneously; the upper cover will partially open.
5. Refer to Figure 5. Insert the cleaning card into the media chute until $\frac{1}{4}$ inch is visible from the front of the printer.
6. Close the upper cover of the printer.
7. Press and hold the Eject button.
8. Turn on the printer power.
9. Hold the Eject button for approximately 15 seconds while the printer powers up and performs a self-test.
10. Release the Eject button when the cleaning card begins moving; cleaning is complete when the card stops moving. Remove and dispose of the cleaning card after the cleaning process. The cleaning card contains isopropyl alcohol, discard according to your local regulations.
11. Reinsert the media cartridge

Maintenance Diagrams

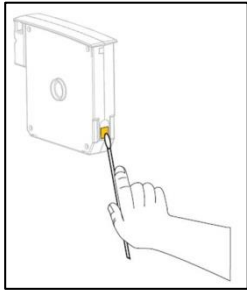

Figure 1



Figure 2

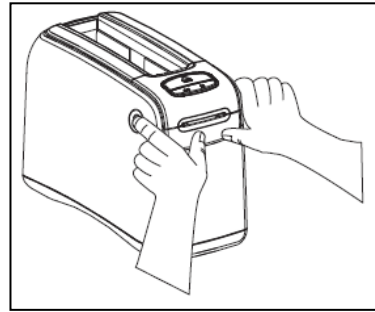

Figure 4

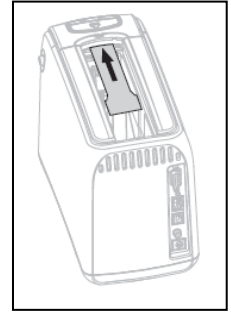

Figure 5

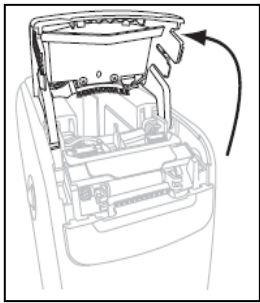

Figure 6

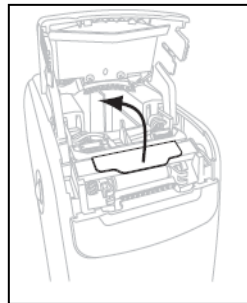

Figure 7

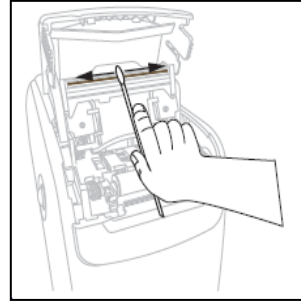

Figure 8

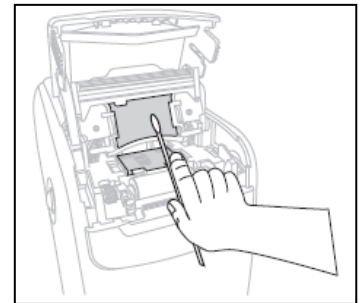

Figure 9



Figure 10

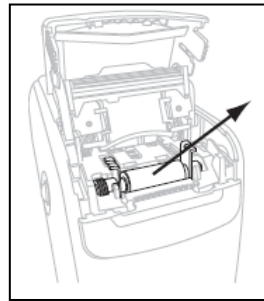

Figure 11

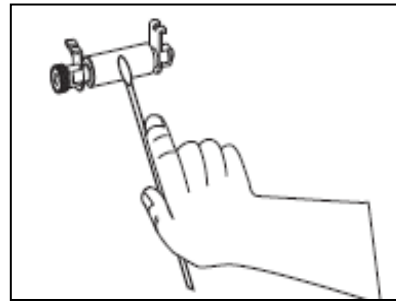

Figure 12

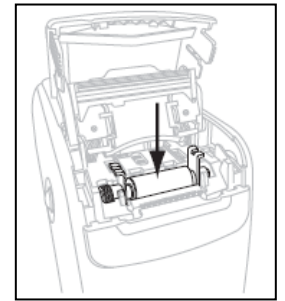

Figure 13

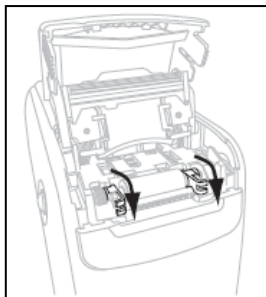

Figure 14

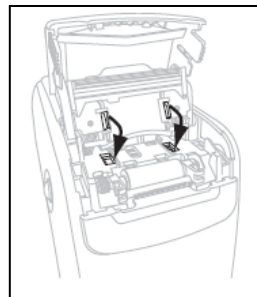

Figure 15

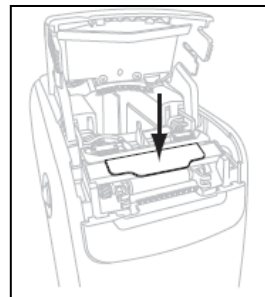

Figure 16

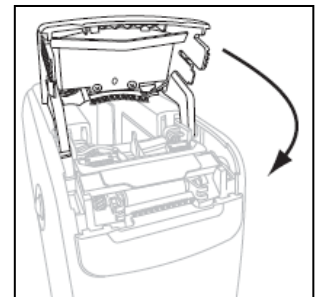



Figure 17

Unexplained Issues

As with all Zebra products, our commitment to quality and reliability ensures that any complaints are investigated thoroughly. Should you experience any issues with your HC100 wristband printing solution which cannot be resolved having followed the guidance from this document, we encourage end users to raise a complaint with their Zebra reseller so that relevant information can be registered with Zebra. In order for a complaint to be investigated in the quickest possible way, we ask that you ensure the following information is included in any correspondence.

Please rest assured that we will continue to record and investigate all complaints in order that you can rely on Zebra's consistently high quality products.

End user			
Zebra Partner/ Reseller			
Cartridge information	Part number		
	Batch number		
	DOM		
Printer information	Part number (see label on underside of printer)		
	Serial number (see label on underside of printer)		
	Firmware version (see page 2 for instructions on how to find firmware version)		
Problem description			